

# Sacha – Steven – Titouan

1 STI2D1 année 20-21

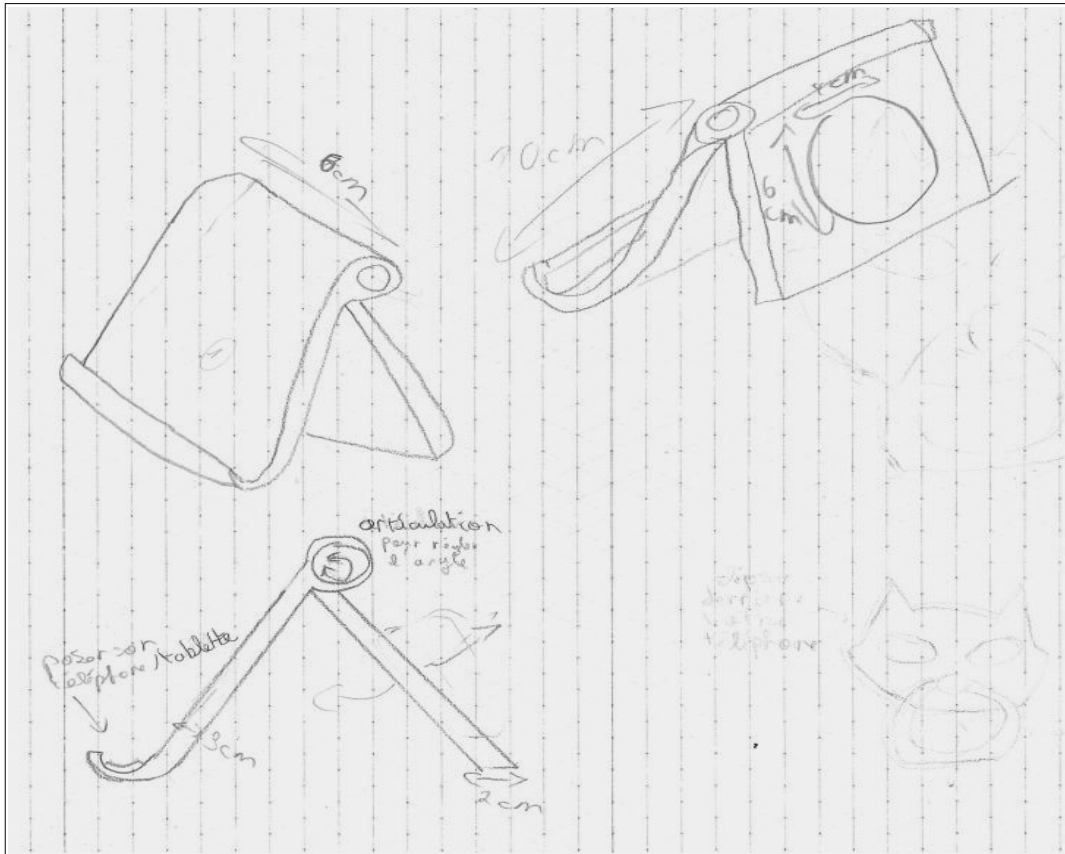
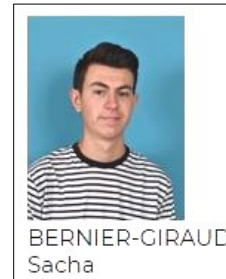

# Mathieu – Flavio – Mathis

1 STI2D1 année 20-21

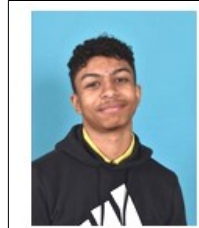

BARAT Mathis



SOARES MARTINS Flavio

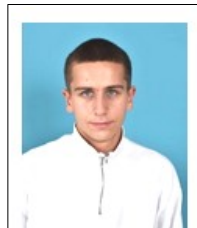

VEIGNEAU Mathieu

1 Piece

Principe 1:

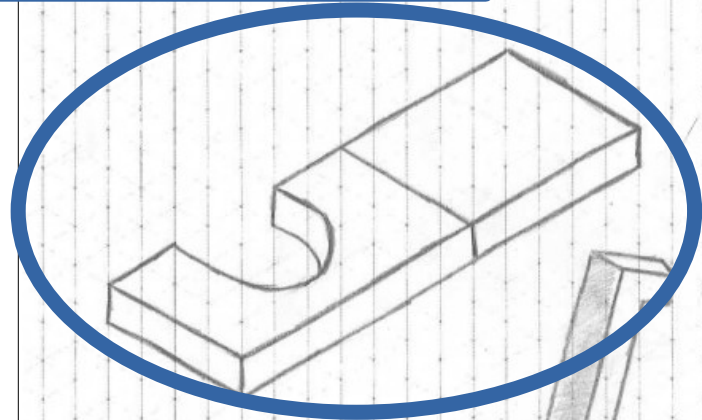

Principe 2:

Axe de rotation

2 Pieces

1 boîte de rangement et de support inférieure

1 petit support supérieure

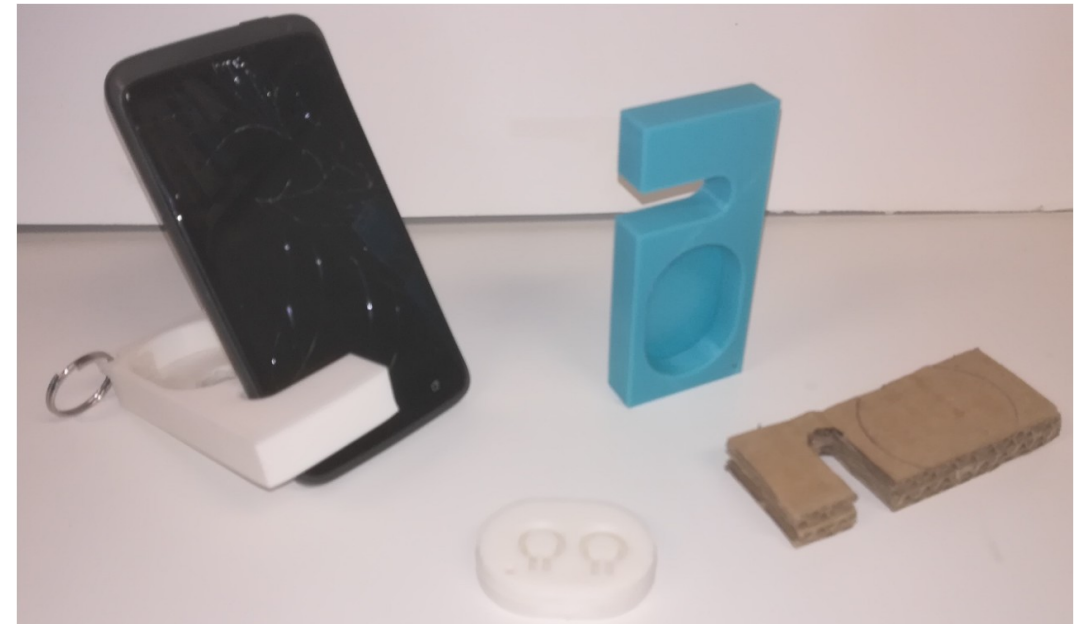

# Liam-Zin – Axel - Bilel

1 STI2D1 année 20-21

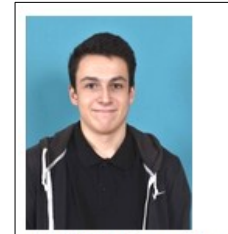

AZZEG Liam-Zine



BEAUVAIS Axel

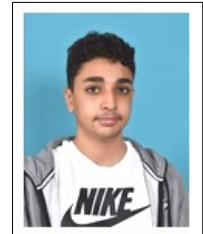

BENOUA Bilel

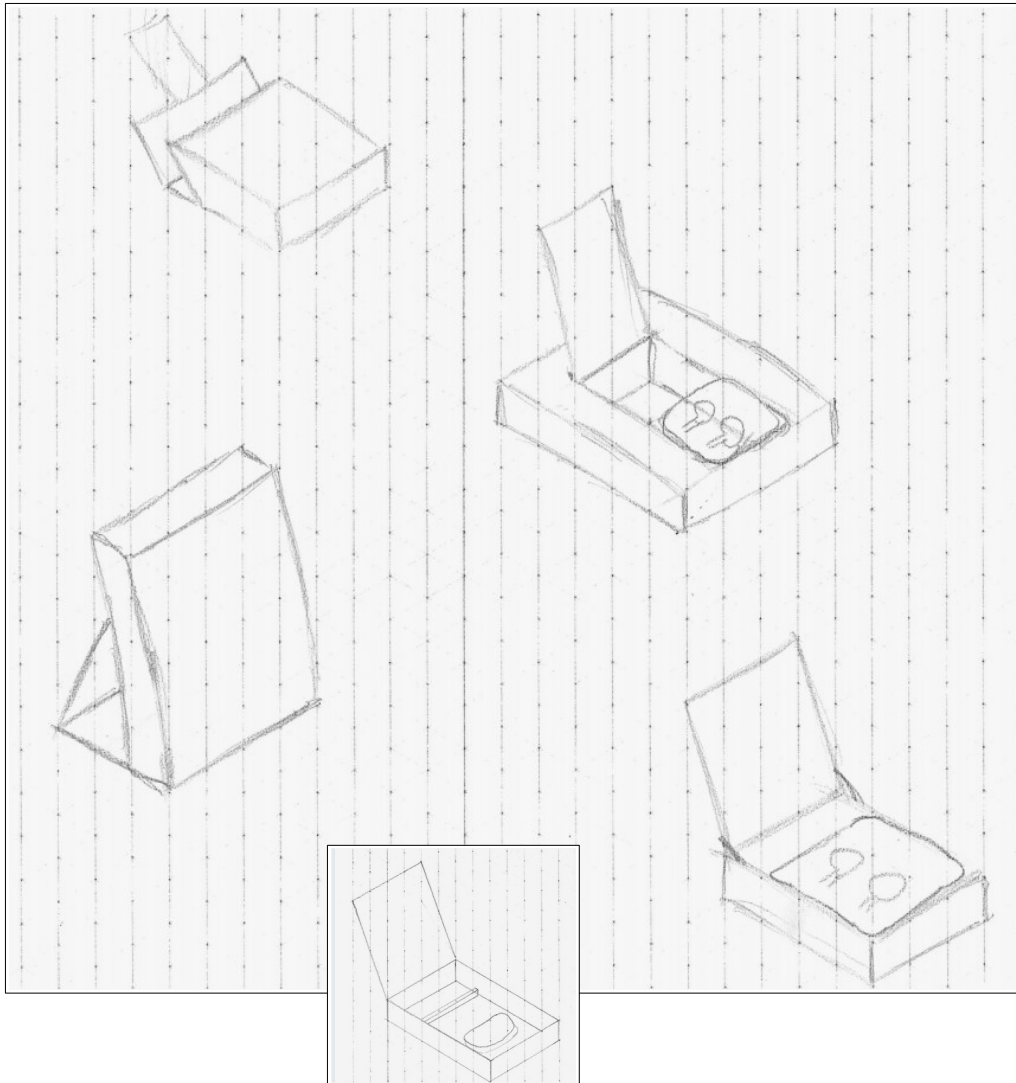

# Antoine - Maelan

1 STI2D1 année 20-21

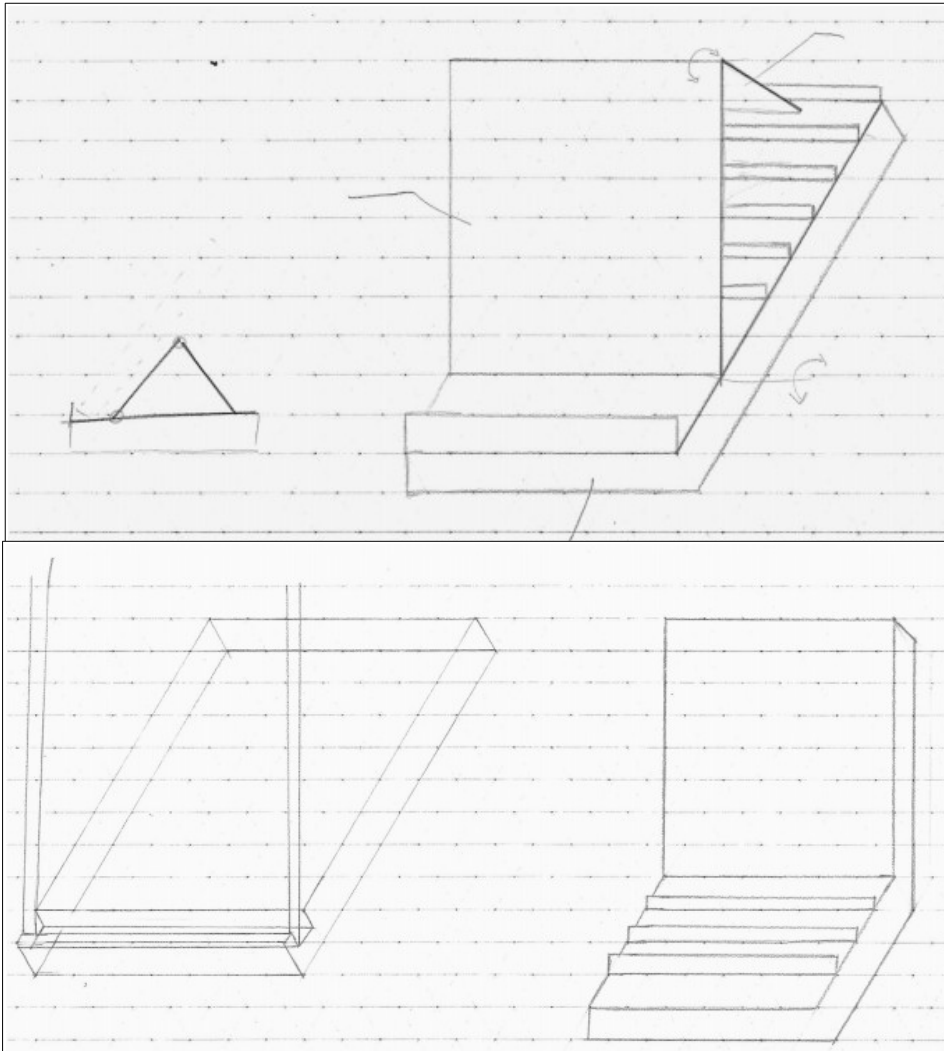

# Kilian- Julien- Axel

1 STI2D1 année 20-21

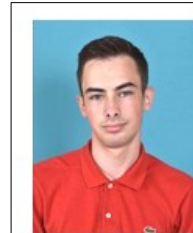

CHANCELIER Kilian



EVARD Julien

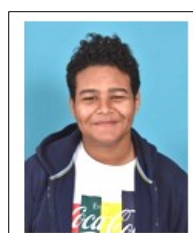

PONET Axel

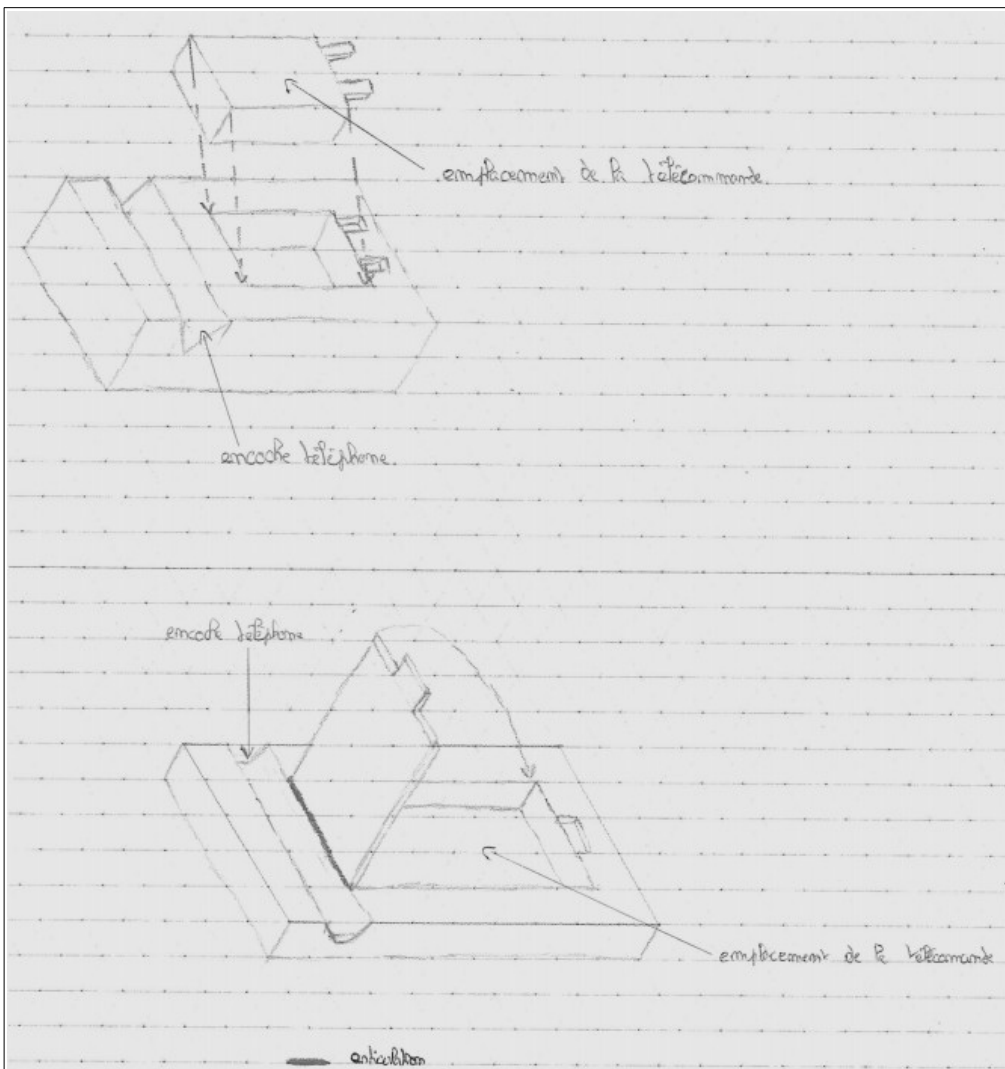

**Yohan – Sula - Nolan**

*1 STI2D1 année 20-21*



EVEN Yoann



MEDJOUBI Sula

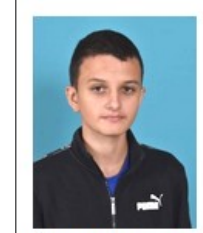

METRO Nolan

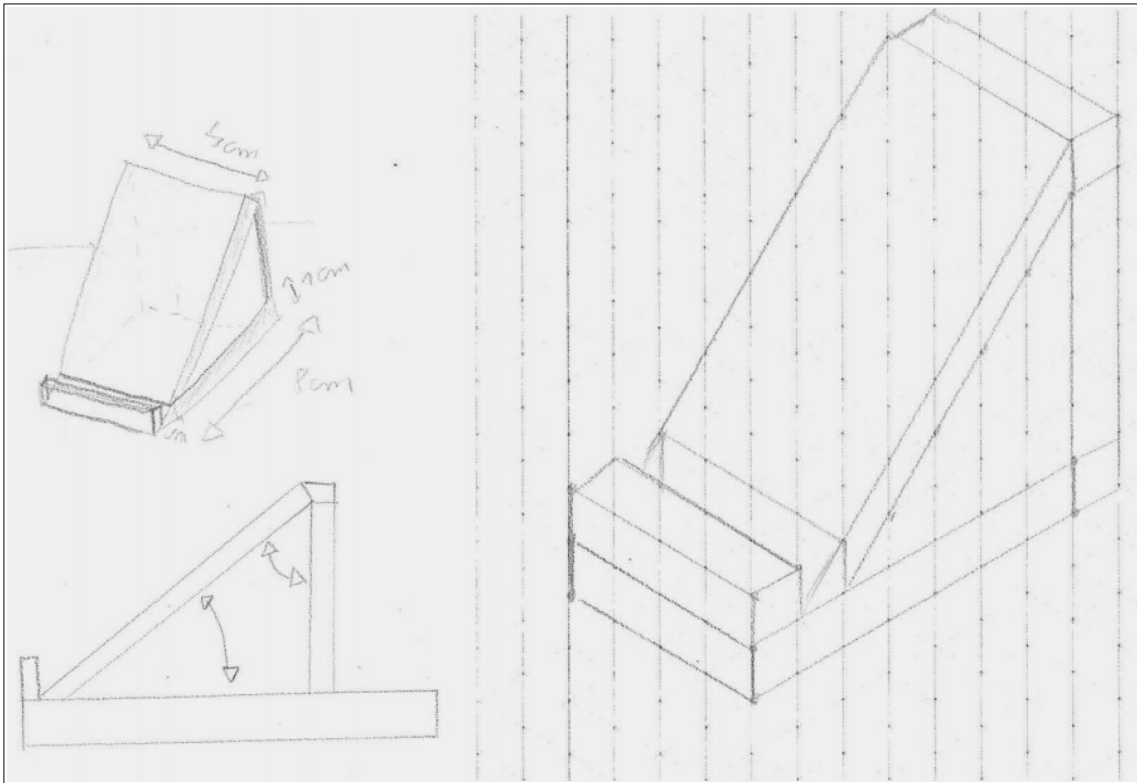

# Elsa - Malo

1 STI2D1 année 20-21

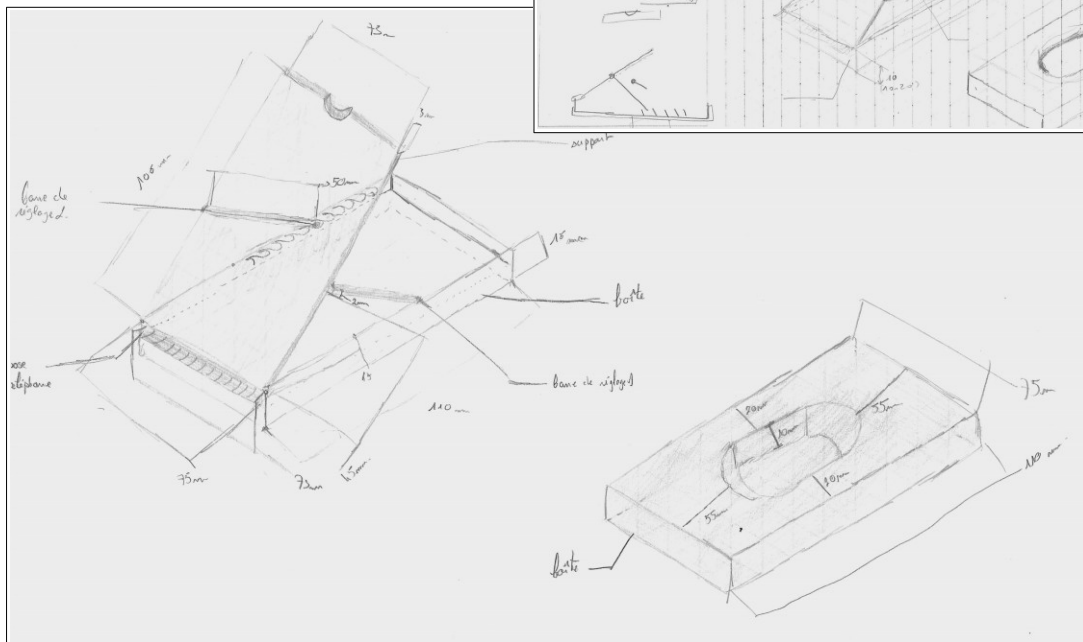
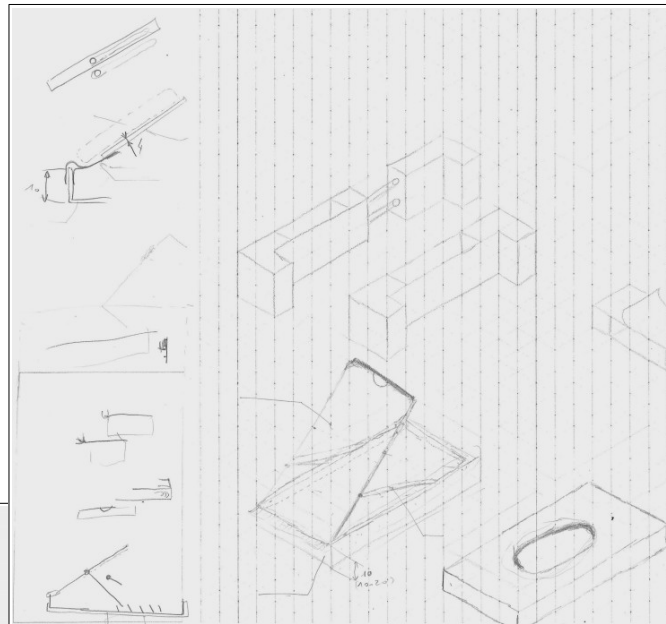
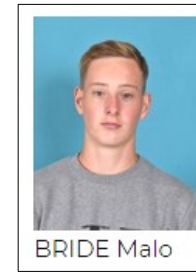

# Noémie – Yassine - Lucas

1 STI2D1 année 20-21



BONNET Noémie



MOUSSAOUI Yassine



PEZERON Lucas

